

المحاضرة الثانية



ابويات المنطقية





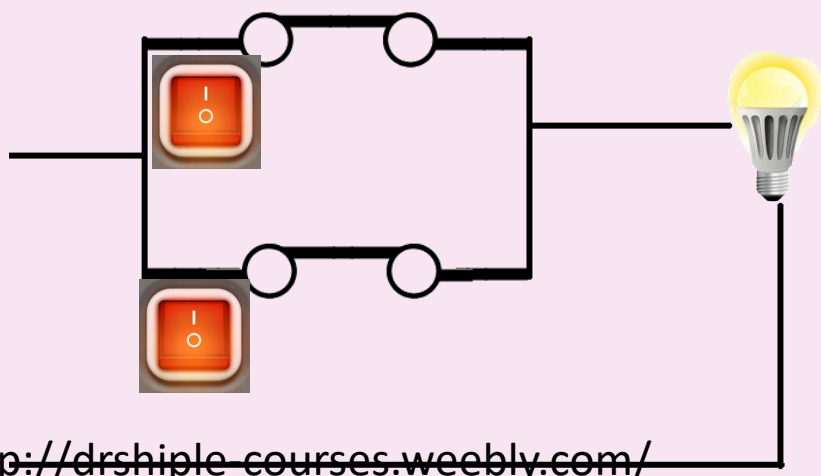
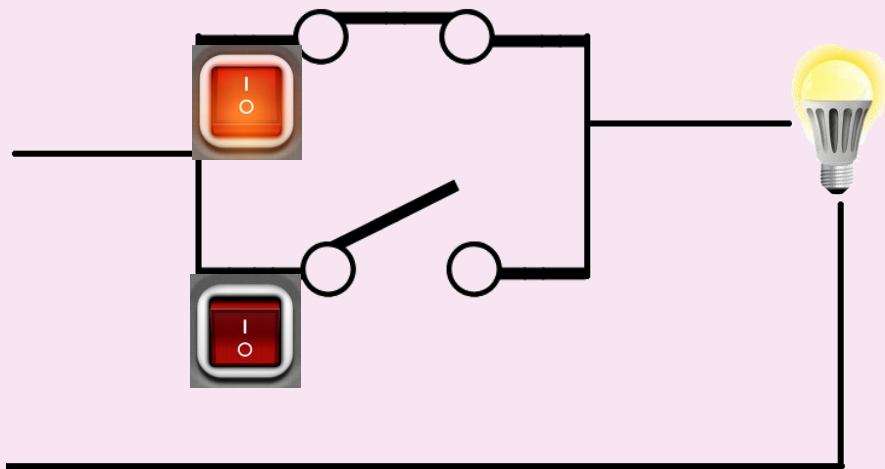
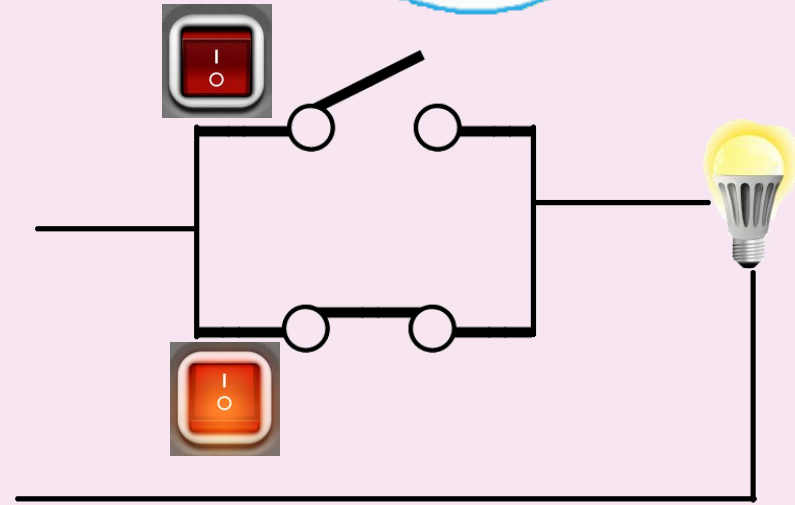
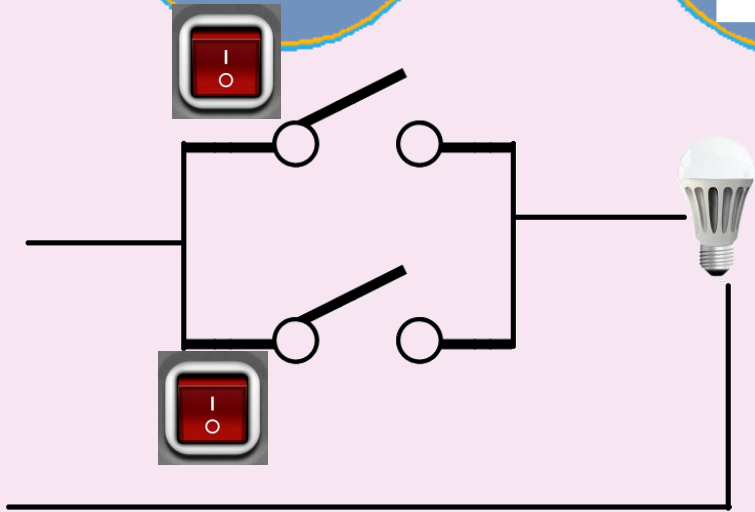
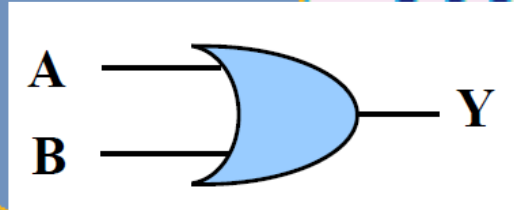

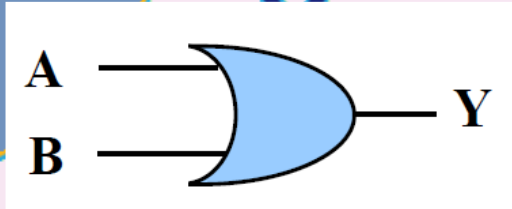

الدكتور مصطفى السيد

بوابة OR



جدول الحقيقة



		
		
		
		

0	0	0
0	1	1
1	0	1
1	1	1

AND بوابة

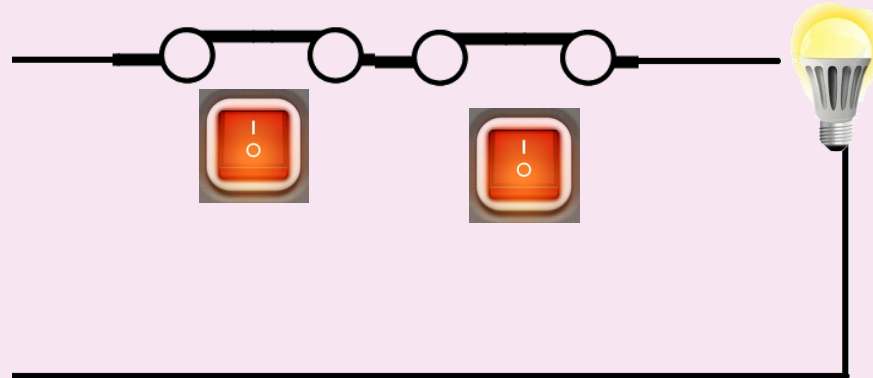
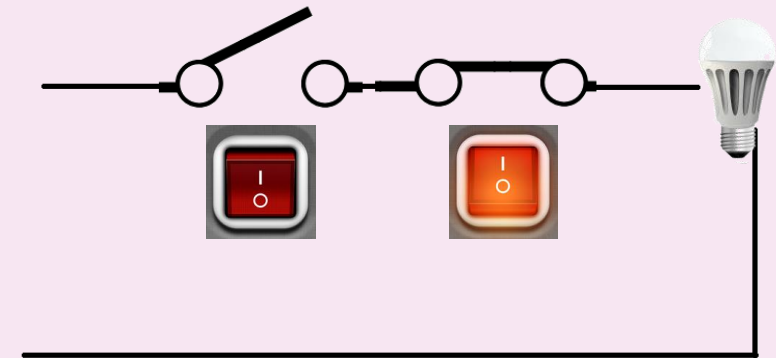
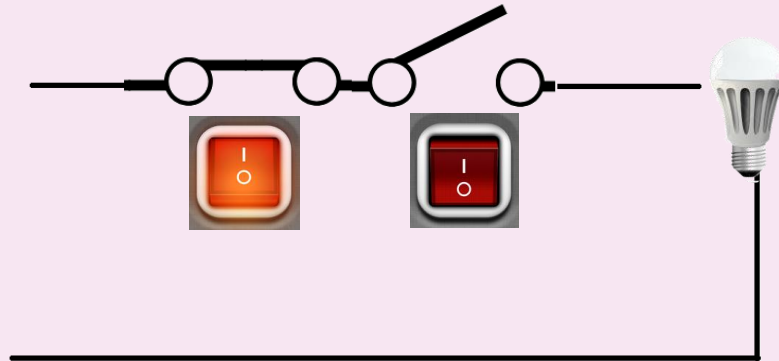
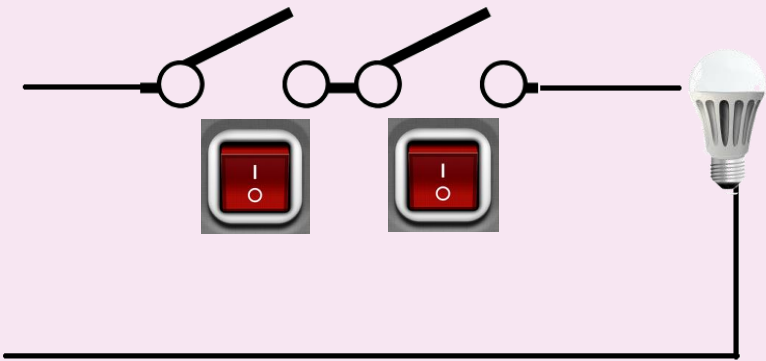
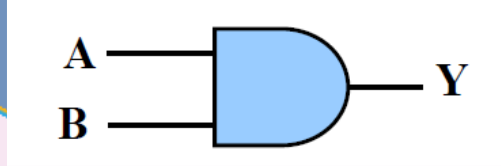

جدول الحقيقة

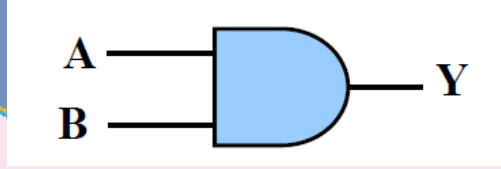

		
		
		
		

0	0	0
0	1	0
1	0	0
1	1	1

بوابة Not

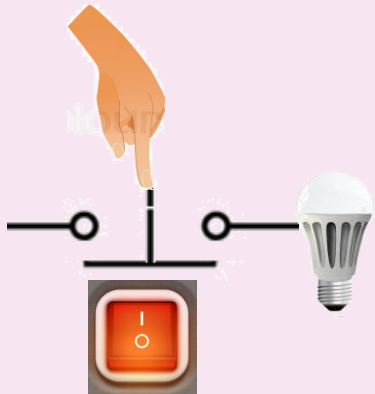
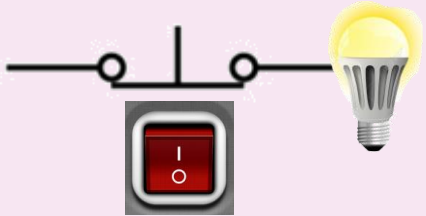
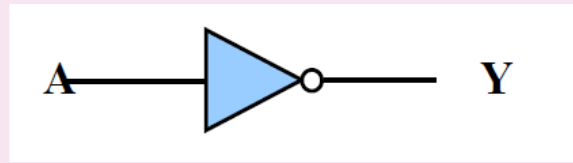

جدول الحقيقة

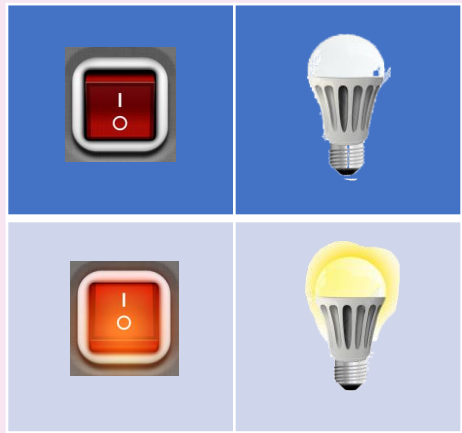
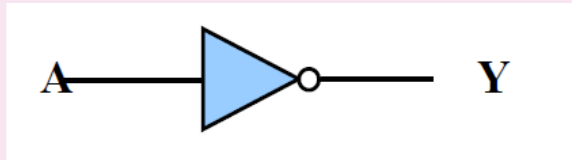

0	1
1	0

NOR بوابة

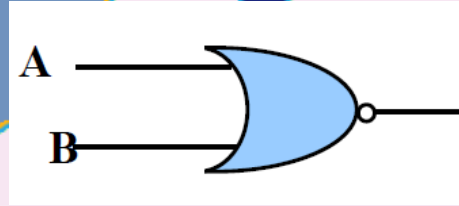

OR

NOR

NOT

جدول الحقيقة

محمّد



?

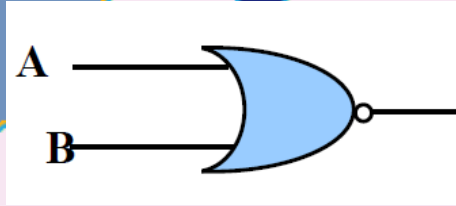

0	0	1
0	1	0
1	0	0
1	1	0

NAND بوابة

مكتبة



AND

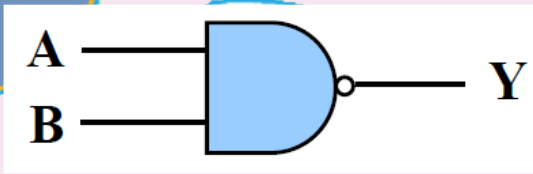

NAND

NOT

جدول الحقيقة

محسب

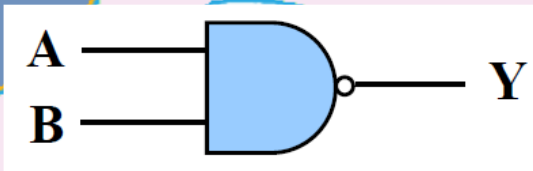





0	0	1
0	1	1
1	0	1
1	1	0

XOR بوابة

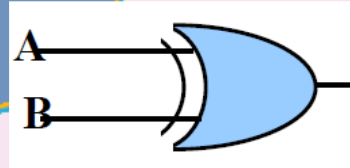

XOR



0	0	0
0	1	1
1	0	1
1	1	0

XNOR بوابة

سلك



XOR

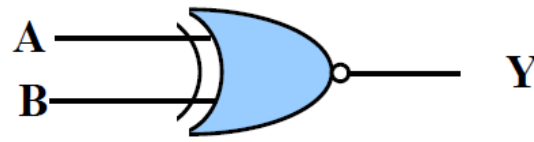

NAND

NOT

جدول الحقيقة

محسب

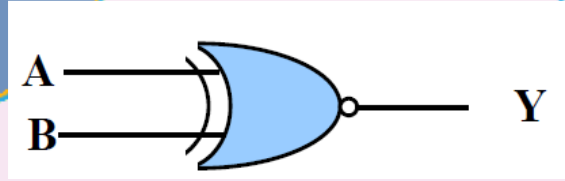

0	0	1
0	1	0
1	0	0
1	1	1

حل الواجب



• حل الاسئلة 1 و 6 من كتاب «دوائر منطقية» صفحة 63